

# Center motor 50970

DATASHEET

## Specifications

Position	<b>Center</b>
Reverse pedaling	<b>Free</b>
Rated Voltage	<b>36 V</b>
Rated Power	<b>250 W</b>
Max. support bike speed	<b>25-32 km/h</b>
Max Torque	<b>70 Nm</b>
Efficiency	<b>Min. 85 %</b>
Walk assist function	<b>No</b>
Pedal Sensor	<b>Speed</b>
Pedal arms	<b>175 mm included</b>
Color	<b>Black/silver</b>
Weight	<b>4,7 kg incl. controller</b>
Operation Temperature	<b>Max. 120°</b>
Wire	<b>IP66 Plug</b>
Max RPM	<b>90 RPM</b>

## Function

Gear sensor Function	<b>Yes</b>
Light Output (DCV / W)	<b>36V / 10 W</b>
Brake cut-off	<b>Yes</b>
Compatible Brake Type	<b>V-brake, Roller brake, Disc brake</b>

## Tests & Certifications

IP classification	<b>IP54</b>
Certifications	<b>CE / EN 15194 / ROHS</b>

## Further specifications

Drive	<b>Sprocket</b>
Sprocket size	<b>38-46 teeth or hub for BCD 104 mm sprocket.</b>
Display protocol	<b>V1</b>
Compatible Wheel Size	<b>20"-29"</b>

## Mounting parameters

Bracket type	<b>PM-01</b>
--------------	--------------

## Cables & connector

- Multi Connector for Wire harness
- Battery connection
- Wheel speed sensor

## DIMENSIONS

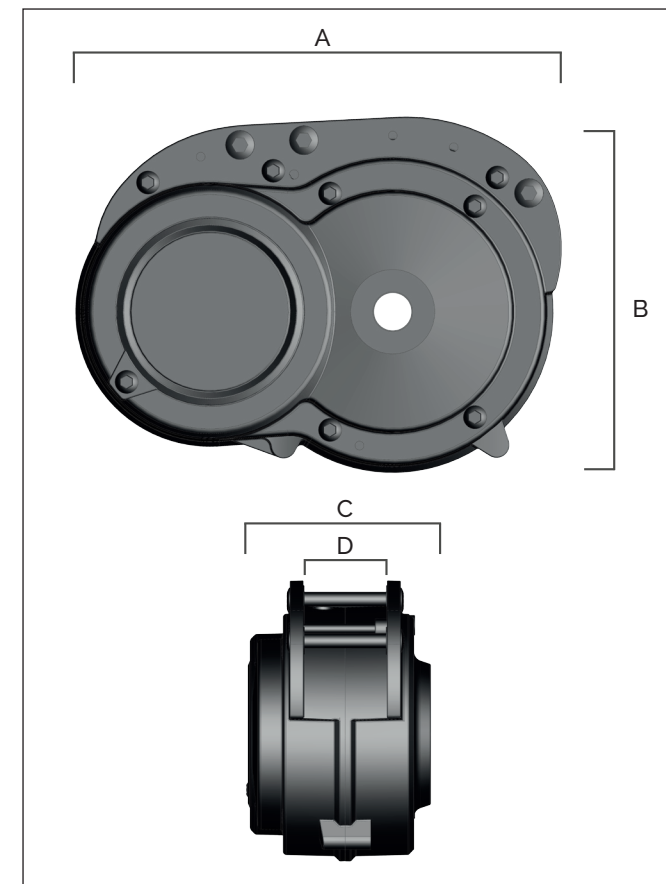

<b>A</b>	207,8 mm	<b>C</b>	98,9 mm
<b>B</b>	151,8 mm	<b>D</b>	45 mm

Jan. 2018, VS\_1