

Display 50713

DATASHEET

Specifications

Assist	5 steps
Battery	5 levels
Light on/off	Yes
Walk-assist	Yes
Protocol	V1
Plug	IP 66
Color LED	Blue
Position	Left

Additional data

Rated voltage	36/48
Weight (g)	70

Mounting parameters

Handlebar (mm)	Ø21
Cable length (mm)	750 mm
Connector	V1

Indication information

Display type	LED
Capacity indication	Yes
Walk assist	Yes
Backlight	Yes
Error indication	Error codes
Km/MPH	Yes

Tests & certifications

IP	IP 65
Certifications	CE / EN 15194 / REACH / ROHS

DIMENSIONS

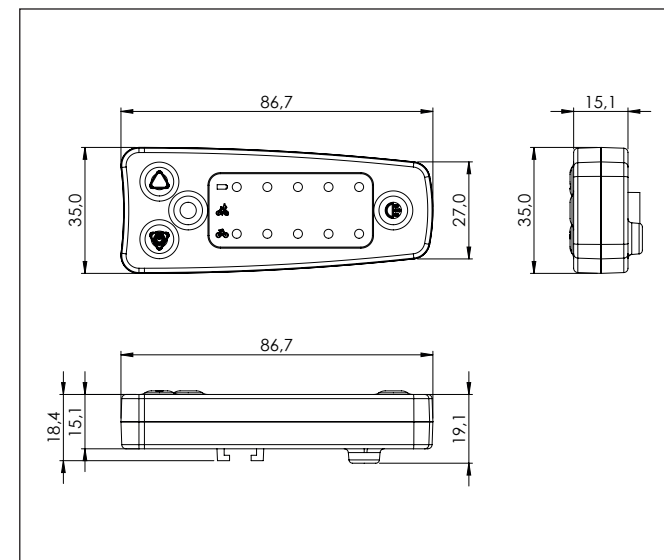

Jan. 2018, VS_1