

Center motor 50970

DATASHEET

Specifications

Position	Center
Reverse pedaling	Free
Rated Voltage	36 V
Rated Power	250 W/500 W (US/CAN)
Max. support bike speed	25-32 km/h
Max Torque	70 Nm
Efficiency	Min. 85 %
Walk assist function	No
Pedal Sensor	Speed
Pedal arms	175 mm included
Color	Black/silver
Weight	4,7 kg incl. controller
Operation Temperature	Max. 120°
Wire	IP66 Plug
Max RPM	90 RPM

Function

Gear sensor Function	Yes
Light Output (DCV / W)	36V / 10 W
Brake cut-off	Yes
Compatible Brake Type	V-brake, Roller brake, Disc brake

Tests & Certifications

IP classification	IP54
Certifications	CE / EN 15194 / ROHS

Further specifications

Drive	Sprocket
Sprocket size	38-46 teeth or hub for BCD 104 mm sprocket.
Display protocol	V1
Compatible Wheel Size	20"-29"

Mounting parameters

Bracket type	PM-01
--------------	--------------

Cables & connector

- Multi Connector for Wire harness
- Battery connection
- Wheel speed sensor

DIMENSIONS

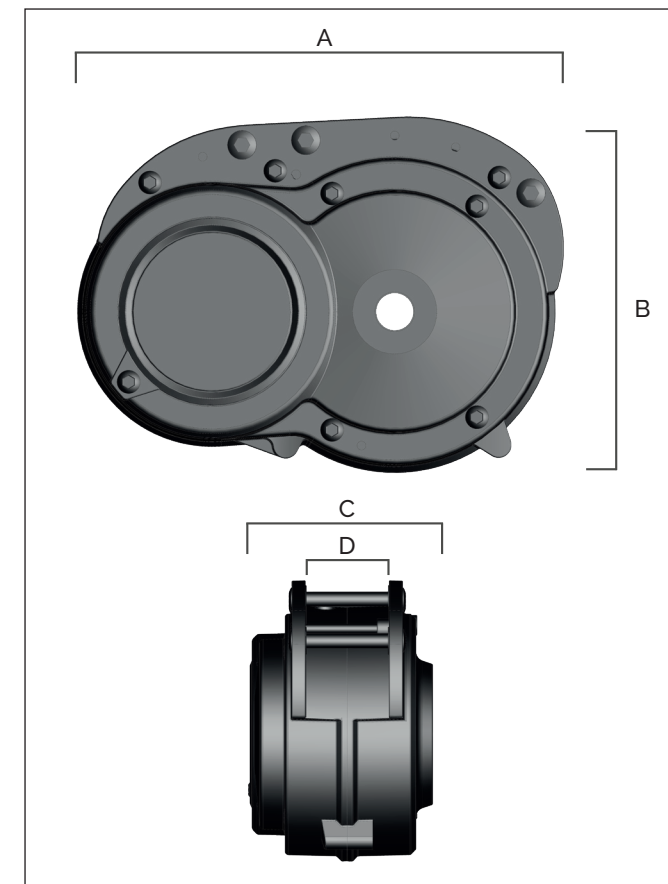

A	207,8 mm	C	98,9 mm
B	151,8 mm	D	45 mm

SEP. 2019, VS_3