

Rear motor 50750-BL

DATASHEET

Specifications

Position	Rear
Freewheel	Yes
Rated voltage	36 V
Rated power	250 W
Max. support bike speed	25 km/h
Max torque	50 Nm
Efficiency	Min. 80 %
Walk assist function	Yes
Color	Black/silver
Weight	3,9 kg
Operation temperature	Max. 120°
Max RPM	250 RPM
Wheel speed sensor	Integrated
Type	BLDC w. hall sensor

Function

Compatible brake type	Disc / V-brake
-----------------------	-----------------------

Tests & Certifications

IP classification	IP54
Certifications	CE / EN 15194 / ROHS

Mounting parameters

Fork width	138 mm
Axle diameter	Ø12 mm
Slot width	10 mm

Cables & connector

Cable length	220 mm
Connector	IP66 Plug

Spoke specifications

Flange width	38 mm
Spoke hole center-center	156 mm
Spoke hole diameter	Ø3,4 mm

Further specifications

Compatible wheel size	26"-29"
Rear sprocket	Casette Shimano 8, 9, 10 speed

DIMENSIONS

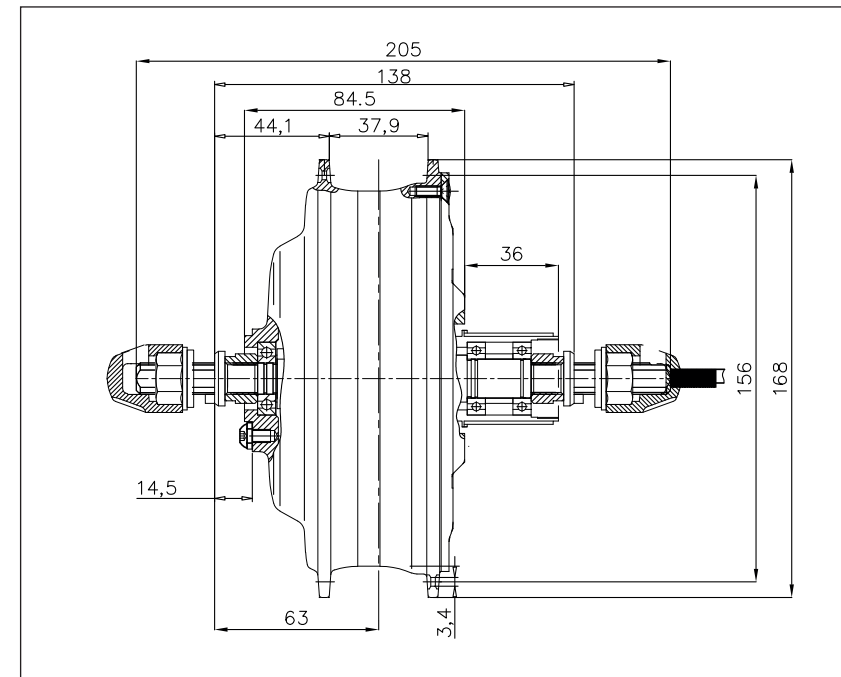

Jan. 2018, VS_1