

# Rear motor 50750-BL

DATASHEET

## Specifications

Position	<b>Rear</b>
Freewheel	<b>Yes</b>
Rated voltage	<b>36 V</b>
Rated power	<b>250 W/350W (US/CAN)</b>
Max. support bike speed	<b>25-32 km/h</b>
Max torque	<b>50 Nm</b>
Efficiency	<b>Min. 80 %</b>
Walk assist function	<b>Yes</b>
Color	<b>Black/silver</b>
Weight	<b>3,9 kg</b>
Operation temperature	<b>Max. 120°</b>
Max RPM	<b>250 RPM</b>
Wheel speed sensor	<b>Integrated</b>
Type	<b>BLDC w. hall sensor</b>

## Function

Compatible brake type	<b>Disc / V-brake</b>
-----------------------	-----------------------

## Tests & Certifications

IP classification	<b>IP54</b>
Certifications	<b>CE / EN 15194 / ROHS</b>

## Mounting parameters

Fork width	<b>138 mm</b>
Axle diameter	<b>Ø12 mm</b>
Slot width	<b>10 mm</b>

## Cables & connector

Cable length	<b>220 mm</b>
Connector	<b>IP66 Plug</b>

## Spoke specifications

Flange width	<b>38 mm</b>
Spoke hole center-center	<b>156 mm</b>
Spoke hole diameter	<b>Ø3,4 mm</b>

## Further specifications

Compatible wheel size	<b>26"-29"</b>
Rear sprocket	<b>Cassette Shimano 8, 9, 10 speed</b>

## DIMENSIONS

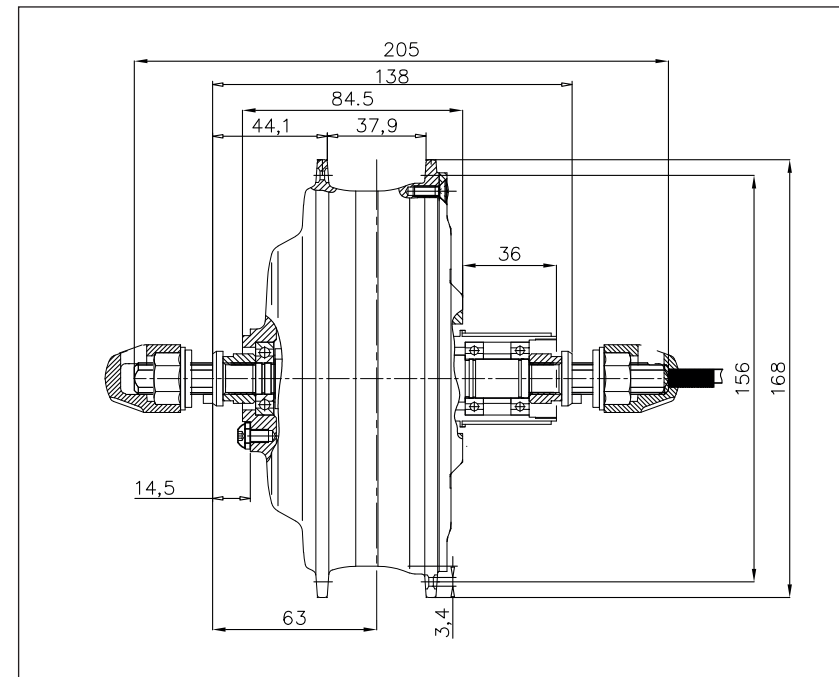

SEP. 2019, VS\_2